



Instruction Manual

Electric ovens Models:

STP 642 (STZ 433 V5)/ STP 643 (STZ 633 V5)/

STB Module



ATTENTION: Please, read these instructions before using this unit.

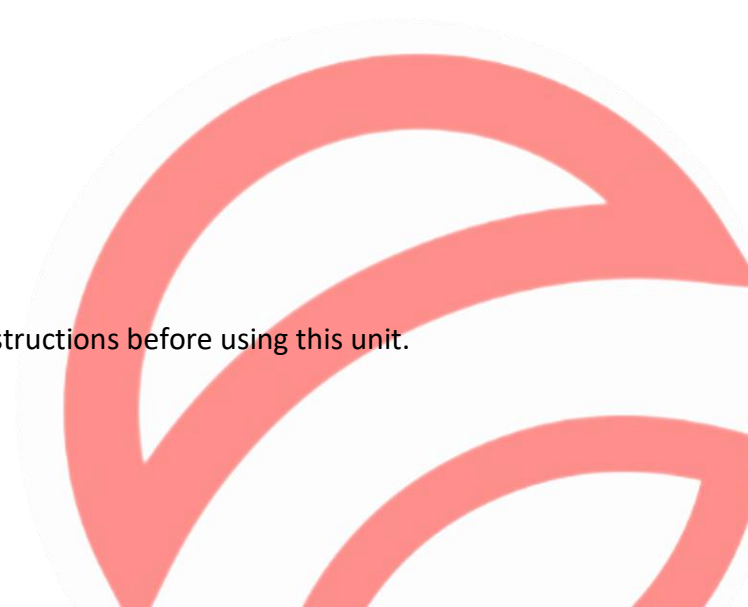

CONTENTS

1.	CE CERTIFICATION	4
2.	WARRANTY	5
3.	GENERAL AND SAFETY STANDARDS	6
4.	SAFETY INSTRUCTIONS, TRANSPORT AND MAINTENANCE	8
4.1	Unpackaging	8
4.2	Transport	8
4.3	Preliminary operations	9
4.4	Placing the unit	9
5.	STARTING UP THE UNIT	11
5.1	Electrical connection	11
5.2	Water inlet (only for ovens with humidication system)	13
5.3	Draining connection (only for ovens with humidication system)	13
5.4	Vapour exhaust from the cooking chamber	16
6.	USE INSTRUCTIONS	17
6.1	Screen. User interface and main settings	17
6.2	Setting a recipe	21
6.3	Programmed automatic start	22
6.4	Using the USB port	23
7.	ALARMS	24

1. CE Certification

UE DECLARATION OF CONFORMITY

Council Directive(s) to which conformity is declared:
DC 2014/35/EU + DC 2014/30/EU + DC 2011/65/EU

Application of the Standards:

UNE-EN 60335-1:2012 + AC:2014 + A11:2014 + A13:2017 + A14:2014 +A2:2020 + A1:2020; UNE-EN 60335-2-42:2004 + Corr:2007 + A1:2008 + A11:2012; UNE-EN 55014-1:2017 + A11:2021; UNE-EN 55014-2:2015; UNE-EN 61000-3-2:2014; UNE-EN 61000-3-3:2013 +A1:2020

Manufacturer's name: **FM CALEFACCIÓN S.L.
CIF: B-14343594**

Manufacturer's address: **CTRA. de Rute km.2.700, C.P.:14900, Lucena
Cordoba, Spain**

Type of device: **HORNO / OVEN**

Marca / Trade.: **FM CALEFACCIÓN**

Model: **STP 642 (STZ 433 V5) / STP 643 (STZ 633 V5)
MÓDULO STB**

We, the undersigned, hereby declare under our sole responsibility that the specified equipment is in conformity with the above Directive(s) and Standard(s)

Place: **Lucena**

Signature: **B-14343594**

Date: **01/01/2021**

2. Warranty

The warranty period is **12 months** from the date of purchase of the unit.

The warranty does not cover damages to the glass, lamps, door seals, damage to the insulating material or damage caused by improper installation or maintenance, lack of maintenance, improper repair or misuse.

To process the repair of a unit under warranty or for any other query, please contact your distributor and refer to the following description table.

Distributor:	Destination country:
Unit model:	Serial number:
Name:	Date of the request:
Fault description:	
Address:	
Contact phone number:	Working hours:



Warning: improper adjustment, installation, service or maintenance of the unit may lead to damages to the goods or persons. For this reason, please, read this manual thoroughly before starting the unit.

3. General and safety standards



Safety standards and responsibility for installing and maintaining

- Read this manual thoroughly before starting the unit and keep it for further consultation. If you need technical support, contact an authorised technical service.
- Installation, starting and maintenance of the oven shall be carried out by qualified technicians in accordance with the scale and technical characteristics specified by the manufacturer. Likewise, observe the current legislation on safety with regard to installations and occupational safety in force in the country of use.
- Check that the unit is unplugged from the power supply before installing or maintaining.
- Before installing the unit, check that installations are in accordance with the current legislation in the country of use and refer to the indications on the data plate.
- Do not manipulate or disconnect the unit safety devices. This will invalidate the warranty.
- Damages, injuries or fatal accidents could be produced due to the non-observance of the manufacturer's indications.
- If the oven is installed on supports or overlaying parts, use the ones supplied by FM only and follow the assembly instructions inside the packaging.
- Non-original spare parts do not ensure the correct operation of the unit and will imply the loss of the warranty.
- The oven must be only used by duly-trained technicians.
- The oven data plate provides the necessary technical information for repair or maintenance. Therefore, avoid removing, damaging or modifying it.
- **Failure to comply with these safety standards will release FM from any responsibility and the warranty will become null and void.**



Safety standards for use

- Please, read this manual thoroughly before starting the unit and keep it for further consultation. If you need technical support, contact an authorised technical service.
- If the unit is not used for a long time, all connections must be interrupted (power supply and water).
- The oven must only and exclusively be used for the purpose it was designed, it is to say, for cooking products such as fresh or frozen bread, pastries and all types of gastronomic products. Any use other than that mentioned may damage the unit.
- Do not put products with a high alcohol concentration into the oven.
- The outside and inside surfaces of the oven should be cleaned frequently to ensure hygiene and proper performance. Do not use abrasive or flammable products, which may damage the unit, to clean those surfaces

- Usage and cleaning different from what is recommended by the manufacturer and with non-authorized products may damage the unit and the user.
- The use of an anti-lime filter at the water supply inlet is recommended. Otherwise, some oven components may be damaged. **Faults caused by lime or water sediment are not included in the warranty.**
- **Failure to comply with these safety standards will release FM from any responsibility and the warranty will become null and void.**



Maximum loads according to the size of the units

CAPACITY	MAXIMUM LOAD	MAX. LOAD PER RACK
4 x (Gn 1/1 o 60/40)	20 kg	Maximum 15 kg per rack
6 x (Gn 1/1 o 60/40)	30 kg	Maximum 15 kg per rack
10 x (Gn 1/1 o 60/40)	45 kg	Maximum 15 kg per rack

- **Never exceed the maximum load capacity to avoid damaging the unit. Failure to comply with these maximum loading values will release FM from any responsibility and the warranty will become null and void.**



Risk of burns

- Read these warnings carefully and follow its indications when the oven is working or not completely cooled down.
- Only touch the unit control elements and the door opening handle. Avoid touching any other external elements of the oven as they may reach temperatures over 60°C.
- Wear thermal mittens or similar to move or handle containers or trays inside the cooking chamber.
- Open the oven door slowly and be careful with high temperature vapours coming out from the cooking chamber.



Risk of fire

- If you do not clean the unit properly and as often as needed, greases and food leftovers will be accumulated in the cooking chamber and then, become inflamed.
- Only use the products recommended by the manufacturer. Using other products may damage the unit and invalidate the warranty.
- Only use home-use cleaning products and a soft damp cloth to clean the outside coating. Do not use corrosive or irritating substances.

4. Safety instructions, transport and maintenance

4.1 Unpackaging

Visible damages: When receiving the material, enter a detailed description of the break in the PDA or in the delivery note.

General comments such as “damaged packaging” or “damage can be seen”, etc. will not be accepted. Clear photographs showing the damaged good and packaging must be provided.

Hidden damages: When receiving the material and within 24 hours after reception, once the hidden damage has been checked, photographs showing the damaged good and its corresponding packaging must be provided. The transport agency label must be clearly visible. Photographs showing the content only and exclusively will not be accepted.

In either case, transport incidences should be reported to FM Industrial to manage the replacement of the machine.

If visible damages are detected when receiving the packaged machine, indicate “hits to the oven” at the time of the delivery, take photos of the damages and transport agency label on the packaging. Please, contact FM Industrial immediately.

If apparently package is in good conditions, and damages are detected when unpacking, place the original packaging again on the machine, take pictures of the packaging and transport agency label on the packaging. Next, unpack again and take photos of damages to the machine. Please, contact FM Industrial immediately.

4.2 Transport

Before transporting the unit to its installation site, make sure that:

- Fits through the door
- The floor withstands its weight

Transport should only and exclusively be carried out by mechanical means, such as a pallet jack, and always on a pallet.

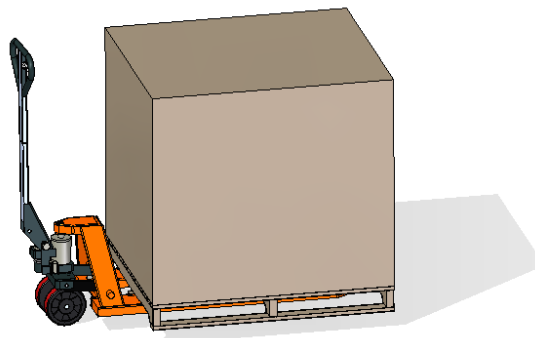

4.3 Preliminary operations

Remove the protection film from the unit. Clean the adhesive residues with an appropriate solvent. Never use abrasive or acid products or tools that may damage the surface.

If your unit is fitted with a core probe kit, remember to remove its silicon protection cap. Otherwise, it could be melted and damage the probe.

4.4 Placing the unit

Place the oven in the selected workplace and keep a safe distance as indicated below. Check that the unit has sufficient cold air inlets through the ventilation registers ensuring correct operation. Otherwise, the unit may overheat, and some components may be destroyed.

- If the oven is installed on an auxiliary support, it must be fixed to it.
- The facilities must be conditioned and meet the regulations in force with regard to safety in installations.
- In addition, the unit must be protected from atmospheric agents.
- The ambient temperature may range between 5°C and 35°C maximum for correct operation of the unit.
- Humidity in the facilities should never exceed 70%.

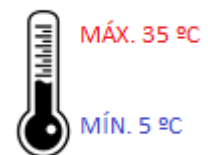
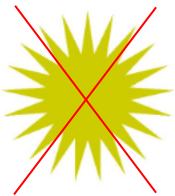

We recommend leaving a 120 mm gap for repair and if there are heat sources or combustible elements, that safety distance must be 700 mm minimum. We also recommend ensuring good ventilation of the unit to prevent overheating its components.



Example of placing the unit without nearby heat sources

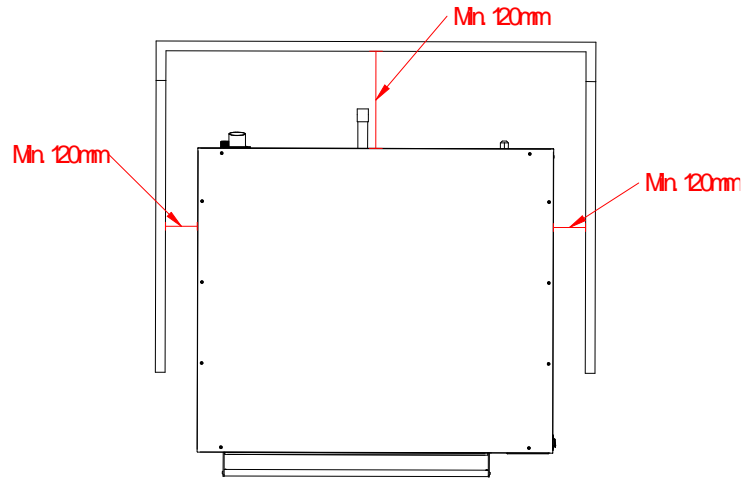

Placing the unit next to heat sources

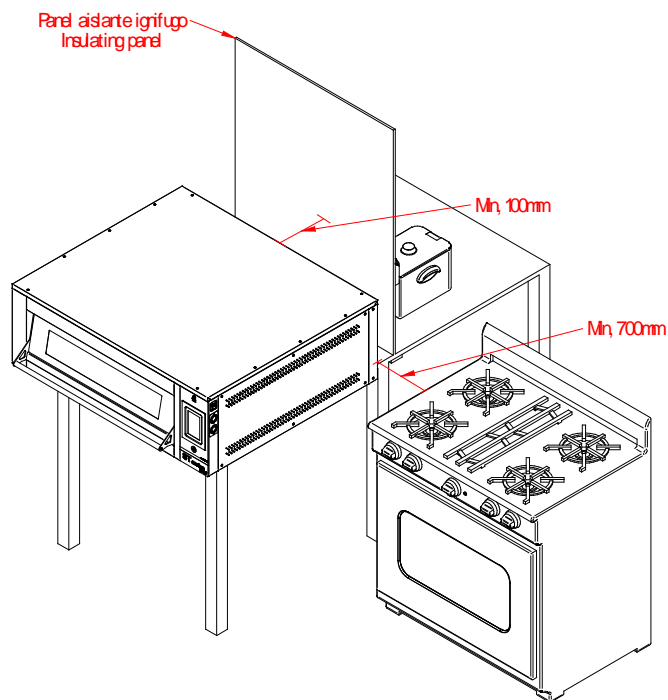

We recommended leaving a free working space of around 500 mm for maintenance operations.



This unit is not suitable for built-in installations.

5. Puesta en marcha del equipo

To start up and install the unit appropriately, please follow the points in the “**DOCUMENT FOR INSTALLING AND STARTING UP SMART UNITS**”, included in the bag together with this instruction manual.

Remember that any fault or breakage resulting from improper installation or starting up, will make the warranty become null and void.

5.1 Electrical connection

Before connecting the unit to the power supply, check that the electrical grid characteristics match those described in the technical characteristics of each unit. The electrical installation must be performed by authorised technicians and meet the regulations in force.

Preferably, the electrical connection should be performed by mounting an electrical outlet (NOT INCLUDED) of appropriate type and capacity for the maximum current absorbed by the oven phases. If not possible, it could be directly connected to the circuit breaker on the electrical control board.

Next, the types of recommended electrical connections are described:

THREE PHASE 400V

- Three phase connection 400V directly connected to a circuit breaker.

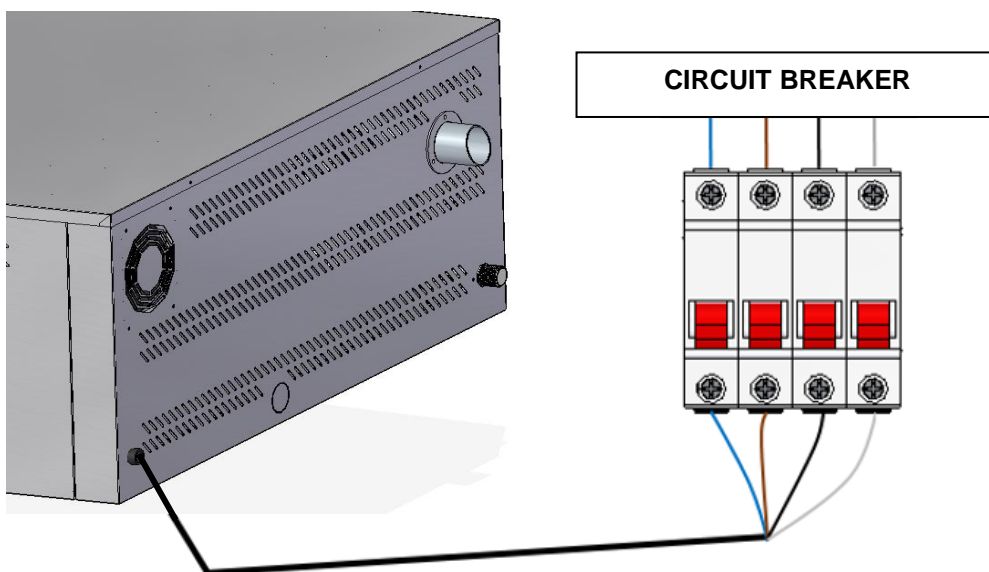

- Three-phase connection 400V connected to a three-phase power socket type CETAC.

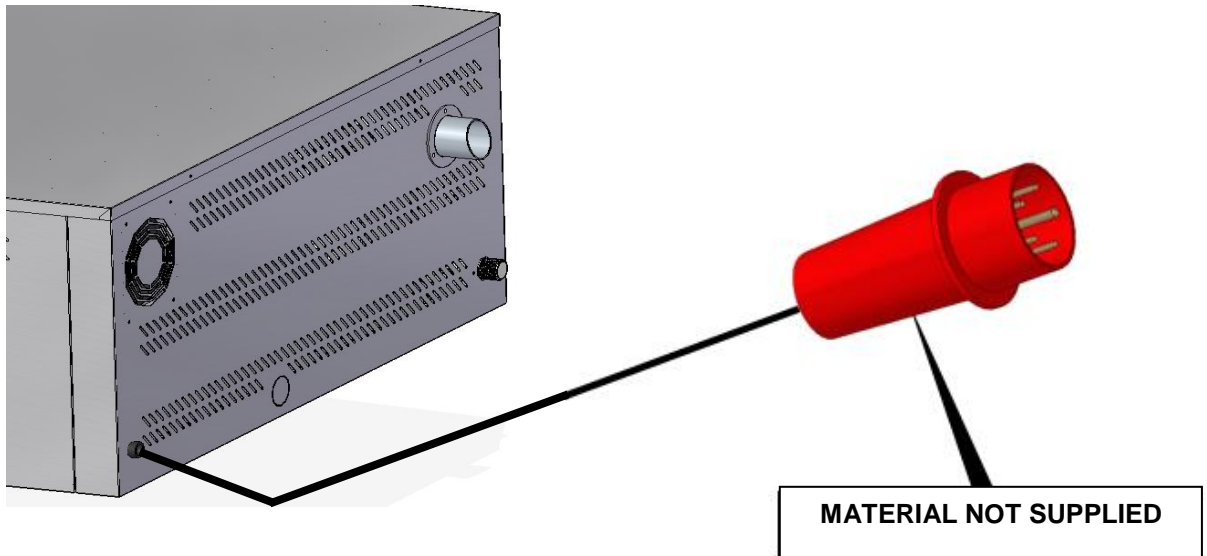

THREE PHASE 230V

- Three phase connection 230V connected to a three-phase power socket type CETAC.

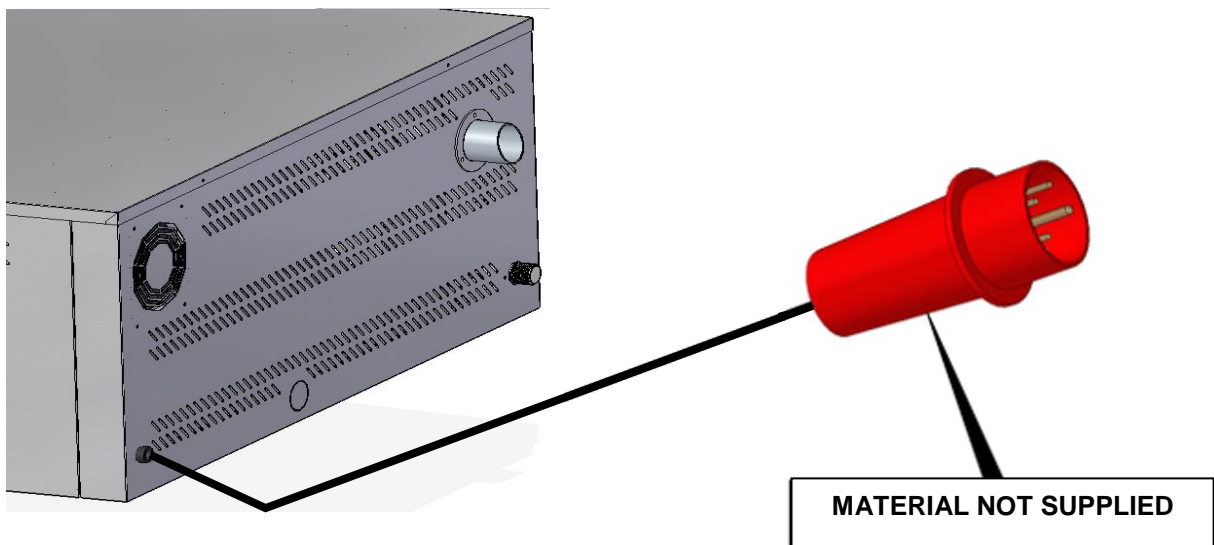

In order to prevent damages from unintentional reset of the cutting thermal device, this unit should not be fed by an external control device, such as a timer, or be connected to a circuit whose supply is regularly interrupted.

An own power supply line protected by an adequately-sized circuit breaker switch and a fixed supply connection is recommended to connect the units.

Observe the colour code of cables. Inappropriate connection may damage the unit.

COLOUR CODE:

PHASES	Grey (L1) 	Black (L2) 	Brown (L3) 
NEUTRAL	Blue (N) 		
GROUNDING	Yellow / Green  		

5.2 Water inlet (only for ovens with humidication system)

The use of an anti-lime filter at the water supply inlet and a check valve is recommended. The oven has a $\frac{3}{4}$ connection for water inlet.

Besides, installing a “digimeter” or digital instrument for measuring the litres of water consumed by the oven is recommended. In this way, you will know when the filter needs be replaced.

Important: Before connecting the water supply, check that there are no residues in the pipe. The pressure of the incoming water should range between 1 and 3 bar, with temperature not higher than 30 °C. If pressure is higher than these values, a pressure reducer at the inlet should be installed.

5.3 Draining connection (only for ovens with humidication system)

- The oven draining connection should be carried out with discharge pipes ensuring thermal stability, the oven gases may reach high temperatures (85-95°C).
- It is recommended to connect the oven draining pipe to a syphon to avoid vapour coming out from the oven. This pipe must be inclined 4% minimum to ensure appropriate operation.
- The draining pipe diameter should NOT be smaller than the draining connection.
- Being specific for each unit. Otherwise, check that the main conduit is dimensioned to ensure the correct flow and without obstacles.
- Having no pinching.

Types of draining:

1. Wall draining:

The wall draining outlet must have a vertical ventilation conduit with a diameter **not smaller than 25 mm**, which must be over the device top cover as shown in the image below.

If there is no vertical ventilation conduit installed, proper draining is not ensured, and it may cause faults and the loss of the warranty.

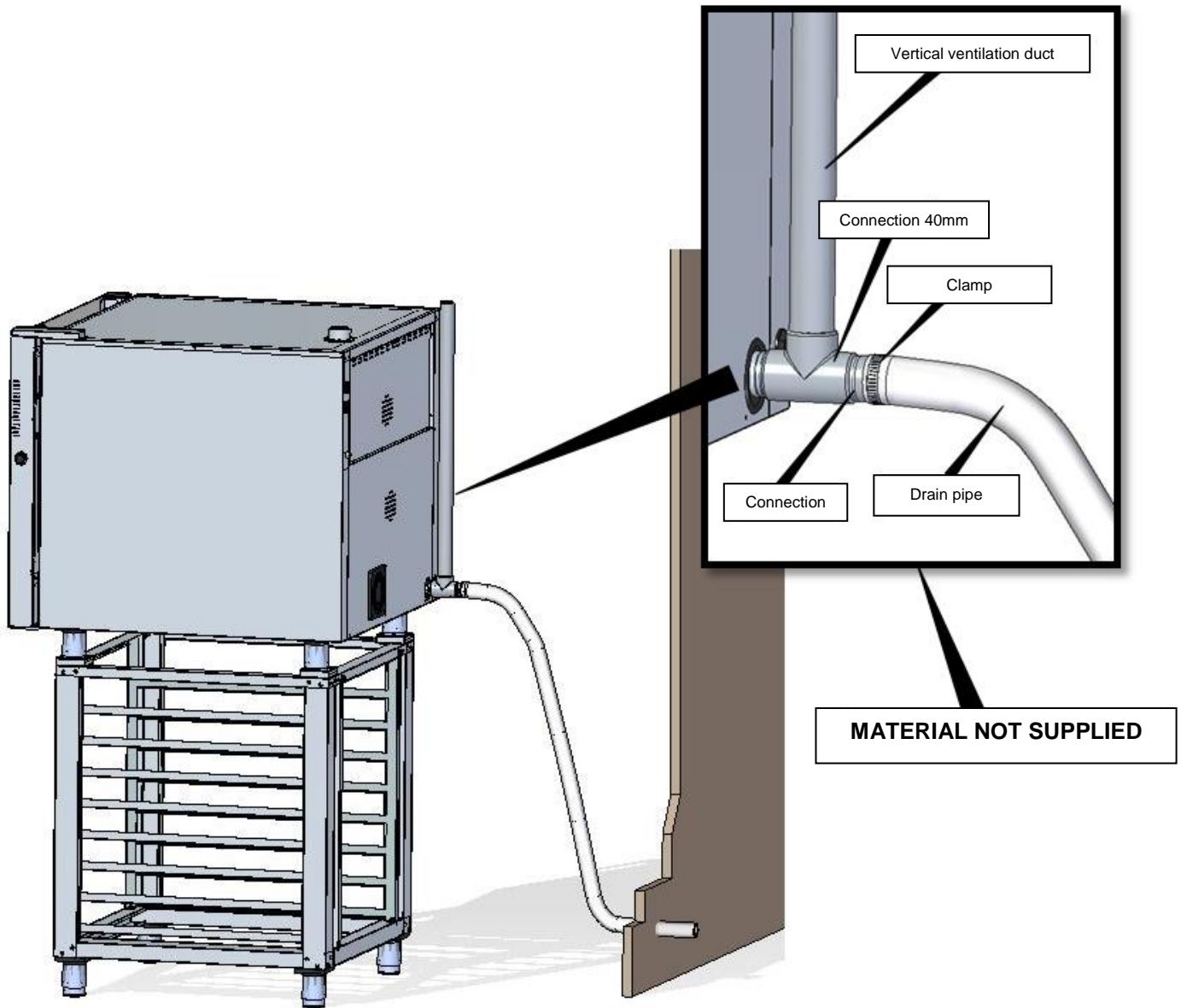

1. Draining separated with a funnel:

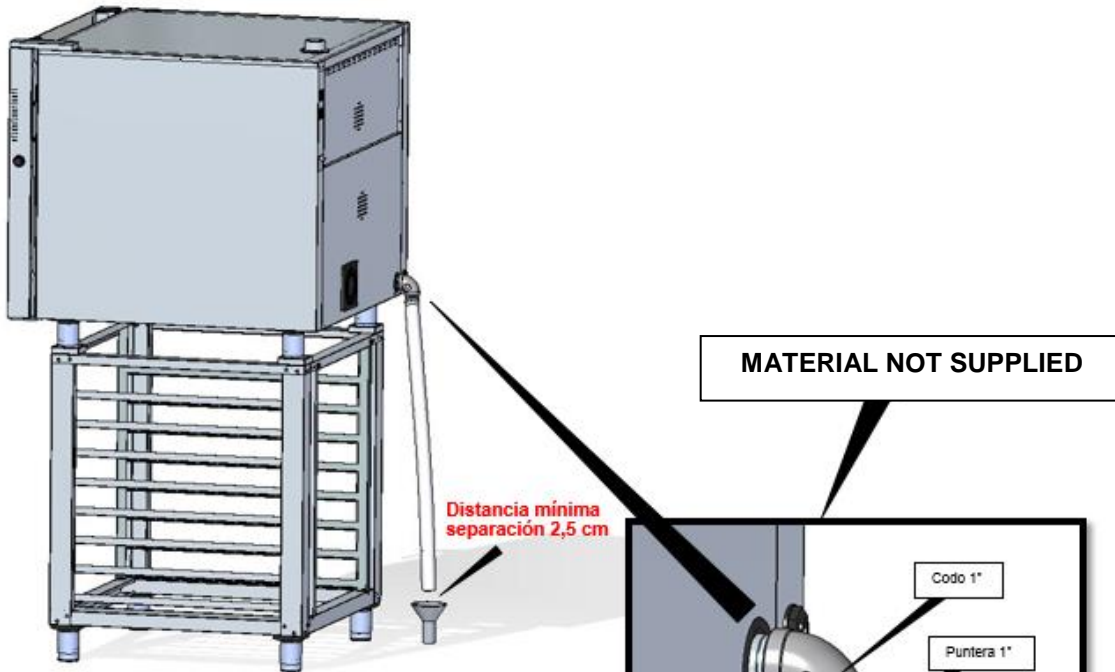

3. Floor draining:

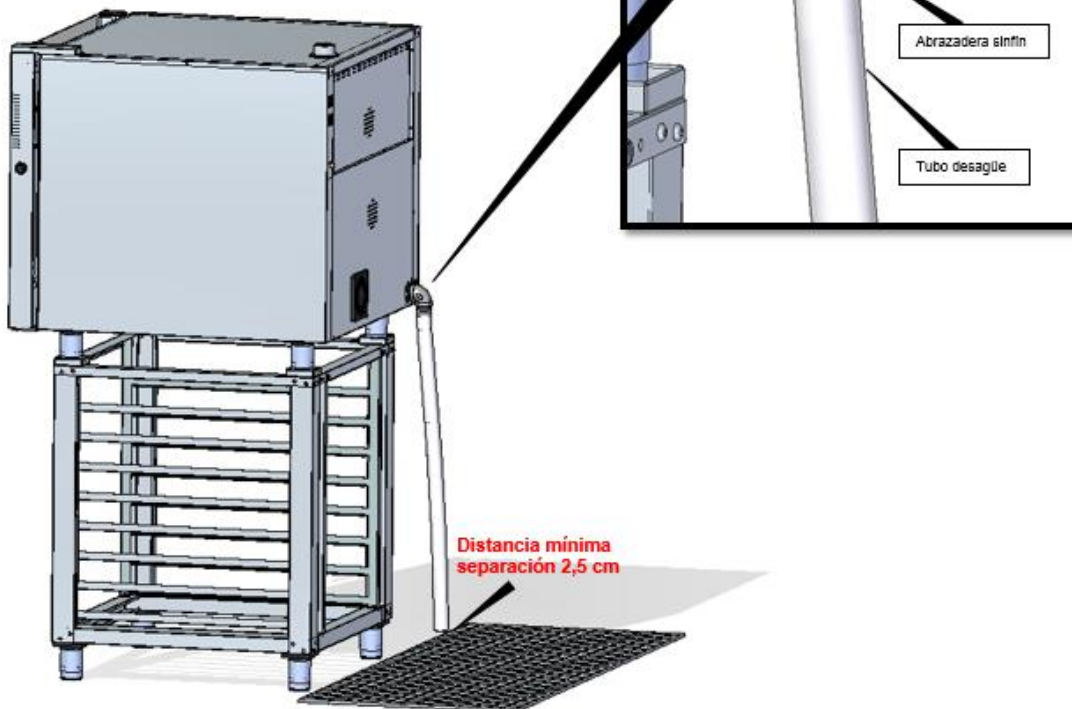

5.4 Vapour exhaust from the cooking chamber

Exhaust gases may be wet and reach high temperatures. Therefore, do not use tubes made of materials not ensuring absolute thermal stability up to 250°C to channel exhaust gases.

A condenser enabling the condensation of vapours and exhaust of those vapours into a drainage may be adapted to treat cooking vapours.

Important: Do not channel the vapour exhaust from the cooking chamber more than 50 centimeters due to risk of condensation. **This pipeline should be vertical and as straight as possible.**

6. Use instructions

Attention! Read this manual thoroughly before starting the unit.

6.1 Screen. User interface and main settings

6.1.1 Switching the unit ON/OFF

Please, follow this step to switch the unit on:

- Press the icon  to activate the screen.



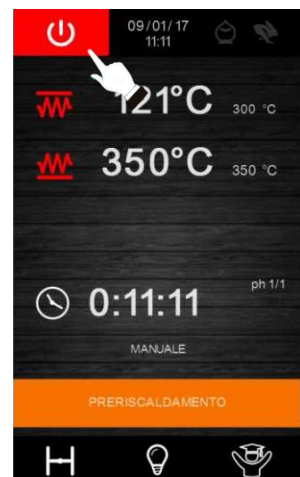

Please, follow these steps to switch the unit off and back to standby mode:

- Check that there are no ongoing operations.
- Press the icon  for 3 seconds to set the screen at standby mode.



6.1.2 Selecting the language







Check that the unit is on and set at standby screen:

1. Press icon  to go to the settings menu, select **“Language”** and then, choose the language you want.
2. Press the icon  to exit and back to the main menu.



6.1.3 Setting the date and time

Check that the unit is on and set at standby screen:

1. Press the icon  to go to the settings menu.
2. Select “Clock” to modify the date and time.
3. Press the icon  several times until the green box is on the digit you want to modify.
4. Press the icons   or move the bar to set the value wanted in the preselected digit.
5. Press the icon  to save.
6. Press the icon  to exit.

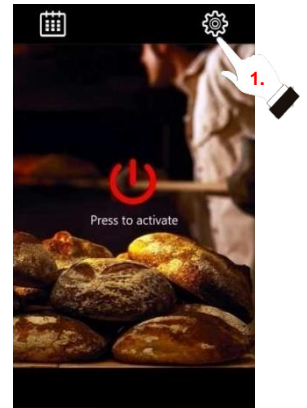

6.1.4 Selecting the language

Check that the unit is on and set at standby screen:

1. Press the icon  to go to the settings menu.
2. Select “Language” to set the language you want.
3. The selected language will be shown immediately without having to confirm.

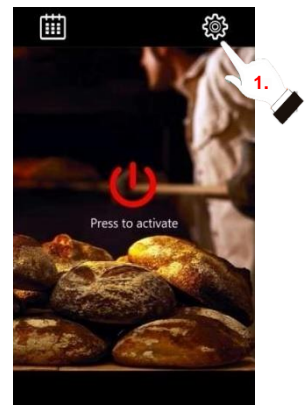

6.1.5 Status bar

When the oven is on, it is working and executing a cooking cycle, the status bar shows the operation mode of the oven at every time.



6.1.6 Injecting humidity (for ovens fitted with a humidifying system only)

If your oven is fitted with a humidifying system for injecting humidity, the icon  will be displayed on the screen. With this icon, injecting humidity can be activated or deactivated during the execution of the cooking cycle.

When pressing this icon, all functions enabled for the humidifying system are displayed.

If the oven temperature is not appropriate to allow for the injection of vapour, the icon will remain yellow.



If the oven temperature is appropriate to allow for the injection of vapour, the icon will turn green.



- The icon “MANUAL” allows for the injection of vapour at manual mode.
- The icon “AUTO” allows the cyclic injection of vapour to be activated if the cooking process is active. If that process is not active, by pressing this icon the cyclic injection of vapour will be activated and preselected.
- The icon “SETUP” allows to access the tool bar to set the parameters of the automatic mode for injecting vapour. In this way, the following values can be set:

1. Duration of the humidity injecting time.
2. Duration of the NON-injecting humidity time.
3. Number of repetitions of the injecting/NON-injecting humidity cycle.

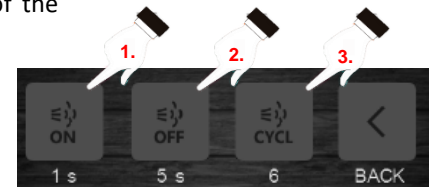

6.1.7 Adjusting the chimney

The icon  adjusts the chimney, closing or opening it, irrespective of whether a cooking cycle is being executed or not.

If the oven is not executing a cooking cycle, hold down this icon to set the time we want the chimney to open before finishing the cooking process.

6.1.8 Internal lighting



The icon switches the lighting in the internal chamber on or off.

6.1.9 Saving energy









The icon activates the saving energy function, except if the fast preheating option has been selected.

6.1.10 "Expert" screen



Press the "Expert" menu button to access a new screen with additional functions and information on the unit status.

If no cooking cycle is being executed, the functions available are as follows:

1.  Displaying internal values.
2.  Selecting a recipe from the cookbook.
3.  Saving a recipe preset in the cookbook.
4.  Adding a phase to a recipe.
5.  Deleting a phase of a recipe.
6.  Activating the exhaust hood manually (if available). If you want to activate it, it will switch off after 10 seconds.
7.  Displaying and resetting alarms. If there is an active alarm, the icon will be displayed on the main screen in the box for the date and time.









6.1.11 Summary screen

If no operations are made on the screen for 60 seconds, the screen changes to the summary screen mode in order to ensure higher visibility of the temperatures of resistances, and time and phase of the cooking cycle.







6.2 Setting a recipe

6.2.1 Preliminary information

1. Recipes can be divided into one or more phases, all of them independent of one another.
2. Phases can be created or deleted.
3. Press the icons  or  to move around the various phases, provided that there is not an ongoing cooking cycle.
4. Press the icons  or , or use the scroll bar to set the cooking parameters in each phase.
5. Press the icon  to save the set parameters.
6. Press  to exit the procedure without changes made.

6.2.2 Memorizing a recipe







The oven can save up to a maximum of 99 recipes. The procedure to save a recipe is as follows:

1. Check that the unit is on and that there is no ongoing cooking cycle.
2. Set a cooking cycle by creating one or several phases as described in the above section.
3. Go to the “EXPERT” screen (see section 6.1.11) and press the icon “Save a recipe”.
4. Press the icons  or  to move around the cookbook pages and select the position you want to save the recipe. Then, enter a new name to that recipe or overwrite an already existing one.
5. Press the icon  to save the set parameters.
6. Press  to exit the procedure without changes made.



6.2.3 Selecting a saved recipe

Follow these steps to select a saved recipe:

1. Check that the unit is on and that there is no ongoing cooking cycle.
2. Go to the “EXPERT” screen and press the icon .
3. Press the icons  or  and select the recipe you want.
4. Press the icon  to load the recipe setting. The name of the recipe will be displayed at the bottom of the timer.
5. Press the status bar  to start the cooking cycle.
6. Follow the steps to set a manual recipe to change the parameters of the ongoing recipe.
7. After starting the cooking cycle, the status bar will change to . Just press it to stop that cycle.

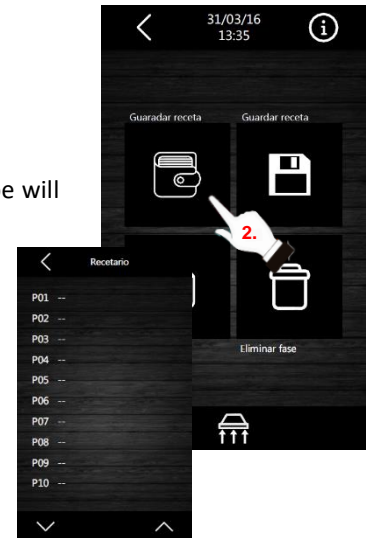

6.2.4 Deleting a recipe



Follow this step to delete a recipe:

1. From section 4 of point 6.2.3, press the icon  to delete the selected recipe.





6.3 Programmed automatic start

The automatic start function allows the user to program up to 9 weekly starts of the oven. In this way, the oven will be activated on the programmed day at the selected time and will reach the temperature setpoint of the recipe selected in the program.

6.3.1 Setting the programmed automatic start

1. Check that there is at least one programmed recipe and that the oven is at standby mode.
2. Press the icon  to go to the programming screen.
3. Press the icon  to select the day you want.
4. Press the icon  to select the time you want.



5. Press the icon  to select the recipe you want.
6. Press the icon  to add a new start programming and repeat the steps above.
7. Press  to delete an already programmed start.
8. Press the icons  or  to move around the various programmed starts.
9. When the automatic start setting is set and saved, the screen shows and suggests its activation when moving to the standby mode. If there is more than one program saved, the program closest in time will be shown for activation.



6.4 Using the USB port

The oven is fitted with a USB port, through which the recipes memorised in the cookbook can be downloaded. To do so, just insert a pen drive (empty and/or formatted) and press the option you want.

The rest of functions displayed when inserting the pen drive, such as loading and downloading parameters, can only be used by the authorised technical service.

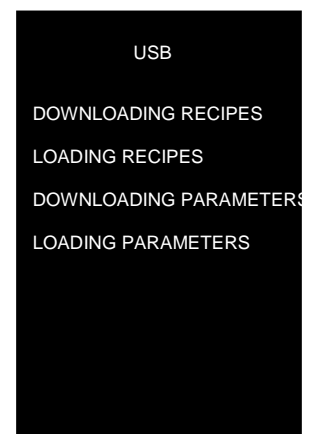

7. Alarms

If an alarm is produced, the buzzer will be activated and the icon  displayed on the screen in the box for the date and time. Press this icon to stop the buzzer. Press this icon again to go to the “Expert” screen (see section 6.1.10), on which the active alarm is shown.

The icon  will be displayed if an alarm requiring manual restart is produced. Press this icon to activate the procedure to restart that alarm.

The table below shows the meaning of the alarm codes that can be produced in the oven.

ALARM	DESCRIPTION
RTC Alarm	<p><u>Alarm description:</u> <i>RTC (Misconfigured date and time)</i></p> <p><u>Solution:</u></p> <ul style="list-style-type: none"> - <i>Set present date and time for the alarm to stop. To do so, go to Settings → Clock.</i>
TOP/BOTTOM CHAMBER PROBE Alarm	<p><u>Alarm description:</u> <i>Chamber probe</i></p> <p><u>Solutions:</u></p> <ul style="list-style-type: none"> - <i>Check the chamber probes.</i> - <i>Check that the chamber probe is correctly connected to the power board.</i> - <i>If the problem continues, replace the probe.</i> <p><u>Main consequences:</u></p> <ul style="list-style-type: none"> - <i>If the alarm is activated when the unit is ON, no cooking cycle can be started.</i> - <i>If the alarm is activated during a cooking cycle, this cycle will stop.</i> - <i>The outlet for temperature adjustment will be disconnected.</i> - <i>If the alarm does not stop, please, contact The Technical Assistance Service.</i>
POWER FAILURE Alarm	<p><u>Alarm description:</u> <i>Shutting off the power supply or oven switched off improperly. It is activated when there is a power supply shut off or when the oven is switched off improperly. To switch it off properly, the oven must be switched off when “PRESS TO ACTIVATE” is displayed on the screen.</i></p> <p><u>Solutions:</u></p> <ul style="list-style-type: none"> - <i>Press the alarm so that it disappears from the screen.</i>

	<ul style="list-style-type: none"> - Check the unit electrical connection. - Check the unit power supply. - Check that the oven is being switched off when “PRESS TO ACTIVATE” is displayed on the screen. <p><u>Main consequences:</u></p> <ul style="list-style-type: none"> - If the power supply shuts off during a cooking cycle, when the power supply is restored the cycle will start from the beginning of the cycle if the power supply shut off is lower than 240 minutes, otherwise, the cycle will be interrupted. - If the alarm does not stop, please, contact The Technical Assistance Service.
<p>NO-CONNECTION Alarm</p>	<p><u>Alarm description:</u> Without communication between the control module and the screen.</p> <p><u>Solutions:</u></p> <ul style="list-style-type: none"> - Check the wiring connecting the screen to the power board. <p><u>Main consequences:</u></p> <ul style="list-style-type: none"> - If the alarm is activated when the unit is ON, no cooking cycle can be started. - If the alarm is activated during a cooking cycle, this cycle will stop. - If the alarm does not stop, please, contact The Technical Assistance Service.
<p>BASIC COMPATIBILITY Alarm</p>	<p><u>Alarm description:</u> Incompatibility between the control module and installed firmware.</p> <p><u>Solutions:</u></p> <ul style="list-style-type: none"> - Check the firmware version of the control module. <p><u>Main consequences:</u></p> <ul style="list-style-type: none"> - If the alarm is activated when the unit is ON, no cooking cycle can be started. - If the alarm is activated during a cooking cycle, this cycle will stop. - If the alarm does not stop, please, contact The Technical Assistance Service.
<p>TEMPERATURE Alarm</p>	<p><u>Alarm description:</u> Alarm for maximum temperature reached at the top or the bottom.</p> <p><u>Solutions:</u></p> <ul style="list-style-type: none"> - Check that the temperature detected by the probe is correct. - If the alarm does not stop, please, contact The Technical Assistance Service. <p><u>Main consequences:</u></p>

	<ul style="list-style-type: none"> - Without consequences.
<p>POWER- BOARD HIGH TEMPERATURE Alarm</p>	<p><u>Alarm description:</u> High operating temperature in the power board or control module.</p> <p><u>Solutions:</u></p> <ul style="list-style-type: none"> - Check that the plate cooling fan works appropriately. - Check that the oven is installed according to the safety distances shown in this manual and that there is no element obstructing the outlet of hot air through the ventilation holes. - If the alarm does not stop, please, contact the Technical Support Service. <p><u>Main consequences:</u></p> <ul style="list-style-type: none"> - If the alarm is activated when the unit is ON, no cooking cycle can be started. - If the alarm is activated during a cooking cycle, this cycle will stop.
<p>SAFETY THERMOSTAT Alarm</p>	<p><u>Alarm description:</u> Safety thermostat.</p> <p><u>Solutions:</u></p> <ul style="list-style-type: none"> - Reset the safety thermostat. - Check that the safety thermostat is dully connected. <p><u>Main consequences:</u></p> <ul style="list-style-type: none"> - If the alarm is activated when the unit is ON, no cooking cycle can be started. - If the alarm is activated during a cooking cycle, this cycle will stop.



FM CALEFACCIÓN S.L.
B-14343594
Carretera de Rute, km. 2'700
14900 Lucena (Córdoba)
www.fmindustrial.es