



Instruction Manual

Electric Ovens

Models:

STC 611/611W V2.4
STC 1011/1011W V2.4

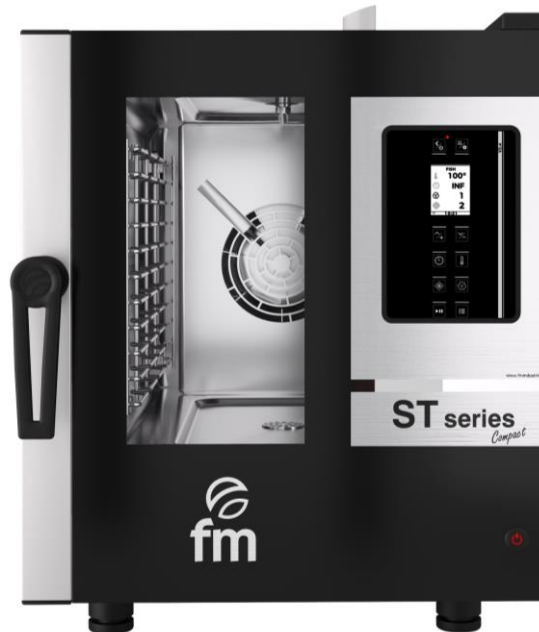

ATTENTION: Please, read these instructions before using the unit.

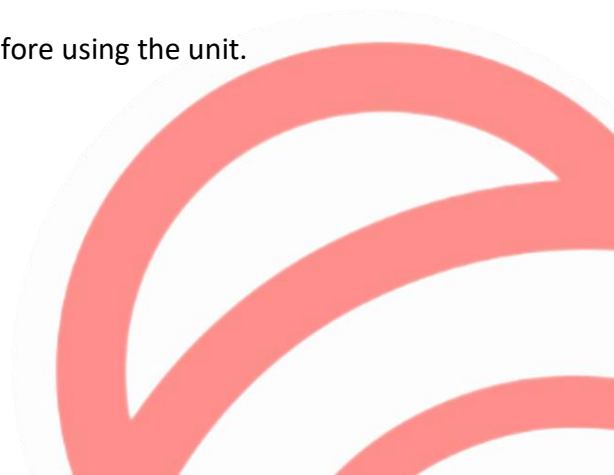

CONTENTS

1. CE CERTIFICATION	4
2. WARRANTY	5
3. GENERAL AND SAFETY STANDARDS	6
4. SAFETY INSTRUCTIONS, TRANSPORT AND MAINTENANCE	8
5. INSTALLING THE UNIT	10
6. INSTRUCTIONS OF USE	12
7. FUNCTIONALITIES	15
8. ADVANCED SETTINGS	24
9. ALARMS AND ERRORS	26

1. CE Certification

EU DECLARATION OF CONFORMITY

*Directiva(s) del Consejo con la(s) que se declara conformidad:
Council Directive(s) to which conformity is declared:*

DC 2014/35/EU + DC 2014/30/EU + DC 2011/65/EU

Application of the Standards:

UNE-EN 60335-1:2012 + AC:2014 + A11:2014 + A13:2017 + A14:2014 +A2:2020 + A1:2020; UNE-EN 60335-2-42:2004 + Corr:2007 + A1:2008 + A11:2012; UNE-EN 55014-1:2017 + A11:2021; UNE-EN 55014-2:2015; UNE-EN 61000-3-2:2014; UNE-EN 61000-3-3:2013 +A1:2020

Manufacturer: **FM CALEFACCIÓN S.L.**
CIF: B-14343594

Manufacturer's address: **CTRA. de Rute km.2.700, C.P.:14900, Lucena
Cordoba, España**

Type of device: **HORNO**

Trade: **FM CALEFACCIÓN**

Model: **STC 611/611W V2.4**
STC 1011/1011W V2.4

We, the undersigned, hereby declare under our sole responsibility that the specified equipment is in conformity with the above Directive(s) and Standard(s)

Place: **Lucena**

Signature: **B-14343594**

Date: **01/01/2024**



2. Warranty

The warranty period is **12 months from the date of purchase of the unit.**

The warranty does not cover damage to glass, lamps, door seals or deterioration of the insulating material or damage attributable to improper installation, maintenance, inadequate repair or lack thereof, as well as improper use of appliance.

To process the repair of a unit under warranty or for any other query, please contact your distributor and reference to the following description table.

Distributor:	Destination country:
Unit model:	Serial number:
Name:	Date of the request:
Fault description:	
Address:	
Contact telephone number:	Time frame:



Warning: *improper adjustment, installation, service or maintenance of the unit may lead to damages to the goods or persons. For this reason, read this manual thoroughly before starting the unit.*

3. General and safety standards



Safety standards and responsibility for installing and maintaining.

- Read this manual thoroughly before starting the unit and keep it for further consultation. If you need technical support, contact an authorised technical service.
- Installation, starting and maintenance of the oven shall be carried out by qualified technicians in accordance with the scale and technical characteristics specified by the manufacturer. Likewise, observe the current legislation on safety and with regard to installations and occupational safety in force in the country of use.
- Check that the unit is unplugged from the power supply before installing or maintaining.
- Before installing the unit, check that installations are in accordance with the current legislation of the country of use and refer to the indications on the data plate.
- Do not manipulate or disconnect the unit safety devices. This will invalidate the warranty.
- Damages, injuries or fatal accidents could be produced due to the non-observance of the manufacturer's indications.
- If the oven is installed on supports or overlaying parts, use the ones supplied by FM only and follow the assembly instructions inside the packaging.
- Non-original spare parts do not ensure the correct operation of the unit and will imply the loss of the warranty.
- The device must be only used by duly- trained technicians.
- The oven data plate provides necessary technical information for repair or maintenance. Therefore, avoid removing, damaging or modifying it.
- **Failure to comply with these safety standards will release FM from any responsibility and the warranty will become null and void.**



Safety standards for use.

- Read this manual thoroughly before starting the unit and keep it for further consultation. If you need technical support, contact an authorised technical service.
- If the unit is not used for a long time, all connections must be interrupted (power supply and water).
- The oven must only and exclusively be used for the purpose it was designed, it is to say, for baking products such as fresh or frozen bread or pastries. Any use other than that mentioned may damage the unit.
- Do not put products into the oven with a high alcohol concentration.
- The outside and inside of the oven should be cleaned frequently to ensure hygiene and proper performance. Do not use abrasive or flammable products, which may damage the unit, to clean those surfaces.
- Usage and cleaning different from what is recommended by the manufacturer and with non-authorised products may damage the unit and the user.
- Do not use direct water jet on the unit in order to avoid damaging its components.
- If the unit has a humidifier, the use of an anti-lime filter at the water supply inlet is recommended. Otherwise, some oven components may be damaged. **Faults caused by lime or water sediment are not included in the warranty.**
- **Failure to comply with these safety standards will release FM from any responsibility and the Warranty will become null and void.**



Risk of burns.

- Read these warnings carefully and follow its indications when the oven is working or not completely cooled down.
- Only touch the unit control elements and the door handle. Avoid touching any other external element of the oven as it may reach temperatures over 60°C.
- Wear thermal mittens or similar to move or handle containers or trays inside the baking chamber.
- Open the oven door slowly and be careful with high temperature steam coming out from the baking chamber.



Risk of fire.

- If you do not clean the unit properly or as often as needed, greases and food leftovers will be accumulated in the baking chamber and then, become inflamed.
- Only use the products recommended by the manufacturer. Using other products may damage the unit and invalidate the warranty.
- Only use home-use cleaning products and a soft damp cloth to clean the outside coating. Do not use corrosive or irritating substances.

4. Safety instructions, transport and maintenance

4.1 Unpacking.

Visible damages: when receiving the material, enter a detailed description of the break in the PDA or in the delivery note.

General comments such as “damaged packaging” or “damage can be seen”, etc. will not be accepted. Clear photographs showing the damaged good and packaging must be provided.

Hidden damages: when receiving the material and within 24 hours after reception, once the hidden damage has been checked, photographs showing the damaged goods and its corresponding packaging must be provided. The transport agency label must be clearly visible. Photographs showing the content only and exclusively will not be accepted.

In either case, transport incidences should be reported to FM Industrial to manage the replacement of the machine.

If visible damages are detected when receiving the packaged machine, indicate “hits to the oven” at the time of the delivery, take photos of the damages and transport agency label on the packaging. Please, contact FM Industrial immediately.

If package is apparently in good conditions, and damages are detected when unpacking, place the original packaging again on the machine, take pictures of the packaging and transport agency label on the packaging. Next, unpack again and take photos of damages to the machine. Please, contact FM Industrial immediately.

4.2 Transport.

Before transporting the unit to its installation site, make sure that:

- Fits through the door
- The floor withstands its weight

Transport should only and exclusively be carried out by mechanical means, such as a pallet Jack, and always on a pallet.

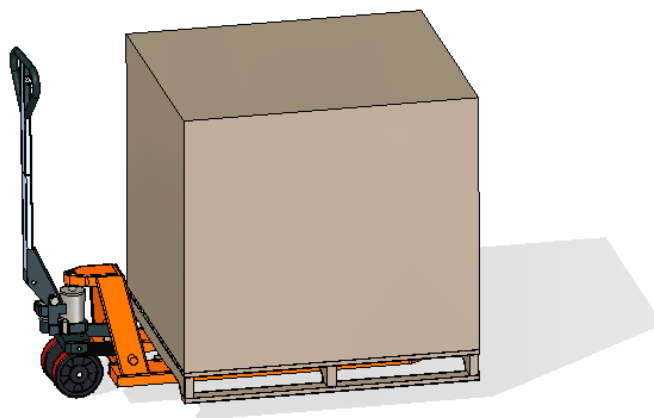

4.3 Preliminary operations.

Remove the protection film from the unit. Clean the adhesive residues with an appropriate solvent. Never use abrasive or acid products or tools that may damage the surface.

4.4 Placing the unit

Place the oven in the selected work place and keep a safe distance as indicated below. Check that the unit has sufficient cold air inlets through the ventilation registers ensuring correct operation. Otherwise, the unit may overheat, and some components may be destroyed.

- If the oven is installed on an auxiliary support, it must be fixed to it.
- The facilities must be conditioned and meet the regulations in force with regard to safety in installations.
- In addition, the unit must be protected from atmospheric agents.
- The ambient temperature may range between 5 and 35°C maximum for correct operation of the unit.
- Humidity should not exceed 70 %.

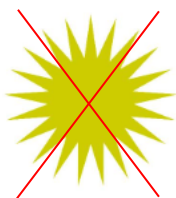

MÁX. 70%



MÁX. 35 °C

MÍN. 5 °C



We recommend leaving a 120 mm gap for repair and if there are heat sources or combustible elements, that safety distance must be 700 mm minimum. We also recommend ensuring good ventilation of the unit to prevent overheating its components.

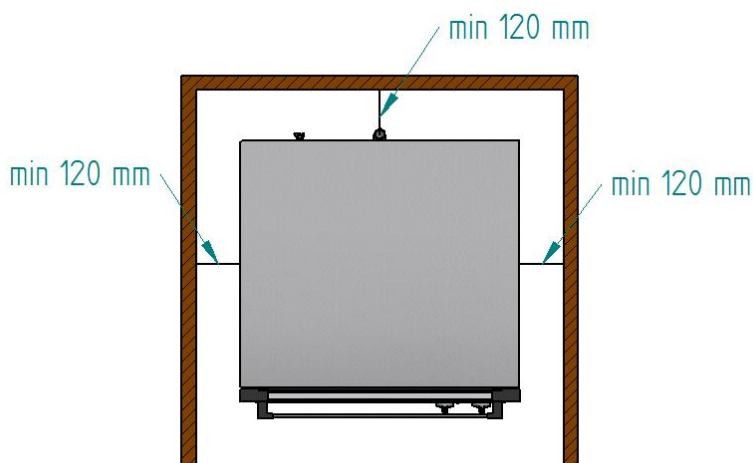

We recommend leaving a free working space of around 500 mm for maintenance operations.

5. Installing the unit

5.1 Electrical connection.

Before connecting the unit to the power supply, check that the electrical grid characteristics match those described in the technical characteristics of each unit. The electrical installation must be performed by authorised technicians and meet the regulations in force.





Preferably, the electrical connection should be performed by mounting an electrical outlet of appropriate type and capacity for the maximum current absorbed by the oven phases. If it is not possible, it could be directly connected to the circuit breaker on the electrical control board.

In order to prevent damages from unintentional reset of the power failure thermal device, this unit should not be fed by an external control device, such as a timer, or be connected to a circuit whose supply is regularly interrupted.

An own power supply line protected by an adequately sized magneto-thermic switch and a fixed supply connection is recommended.

Observe the colour code of cables. Inappropriate connection may damage the unit.

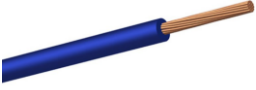
COLOUR CODE:

PHASES	Grey (R) 	Black (S) 	Brown (T) 
NEUTRAL	Blue (N) 		
GROUNDING	Yellow / Green  		

5.2 Salida de vapores de la cámara de cocción.

Los gases de salida pueden ser húmedos y llegar a una temperatura elevada, por lo que para canalizarlos no utilicen tubos de materiales que no garanticen una absoluta estabilidad térmica de hasta 250°C.

Para el tratado de los vapores de la cocción es posible adaptar un condensador que permitirá condensar los vapores y expulsarlos a un desagüe.

Importante: No canalizar más de 50 centímetros la salida de vapores de la cámara de cocción por riesgo de condensación. **Dicha canalización deberá ser siempre vertical y lo mas recta posible.**

5.3 Water inlet.

In case the appliance is equipped with a humidifier, the use of an anti-lime filter at the water supply inlet and non-return valve is recommended. The oven is equipped with a $\frac{3}{4}$ " water inlet connection.

In addition, it is advisable to install a "digimeter" or digital instrument to measure the liters of water consumed by the oven, and thus, to know when it will be necessary to replace the filter.

Important: Before making the water connection, flush the water out to eliminate any possible residues that may be contained in the pipe. The inlet water must have a pressure between 2 and 3 bar, with a temperature not exceeding 30°C. If the pressure is higher than these values, a pressure reducer should be installed at the inlet.

6. Instructions of use

Read this manual thoroughly before starting the unit and keep it for further consultation. If you need technical support, contact an authorised technical centre.

The oven has been designed to bake or regenerate fresh or frozen bakery and pastry products with maximum regulation ranges of 60 minutes and 250°C.

The distance between trays is 80 mm and, whenever possible, we recommend leaving a 70 mm gap between pieces in the same tray to let the air flow effectively.

Likewise, we recommend preheating the oven at working temperature for 20 minutes, which ensures better products finish.

6.1 Using the unit for the first time

Remove the external protection film. If there are residues, use an appropriate solvent and then, rinse with a damp cloth.

The inner chamber and trays should be washed with water and soap and then, work at a 200°C cycle for 30 minutes.



Warning: Never use aggressive or acid products because the unit may be damaged.



Warning: When carrying out maintenance or cleaning operations, disconnect the power supply and wait for the unit to cool down.

6.2 Control panel

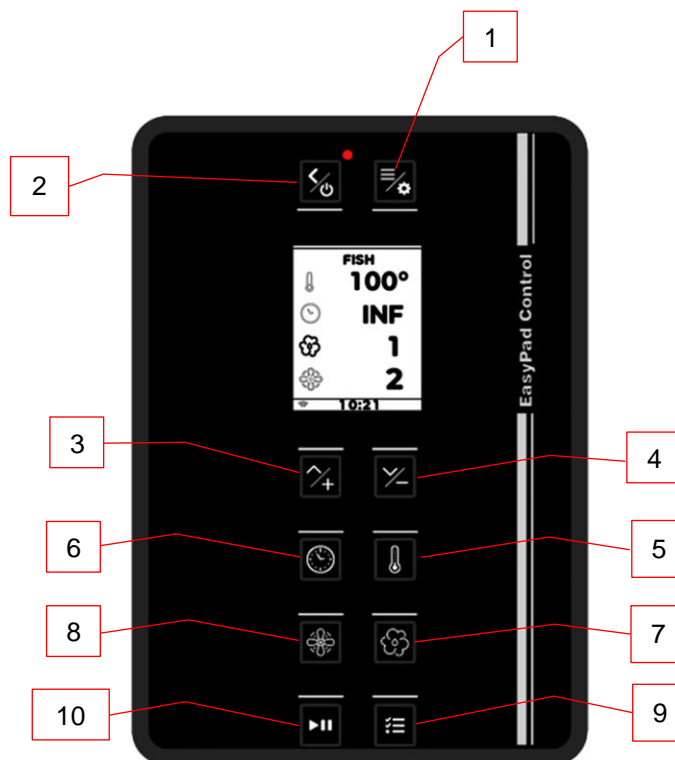

The distribution of the buttons corresponds to the following numbering:

1. Menu/select
2. Back/ON-OFF

3. Up
4. Down
5. Temperature
6. Time
7. Humidity
8. Turbine speed/s
9. Phase management
10. Start/stop

6.3 Ignition

- If the display is in standby mode, the ON/OFF button must be pressed to access the standby screen.
- If the display is on, the ON/OFF button must be pressed and held down to access the standby screen.

Image 1: Standby screen

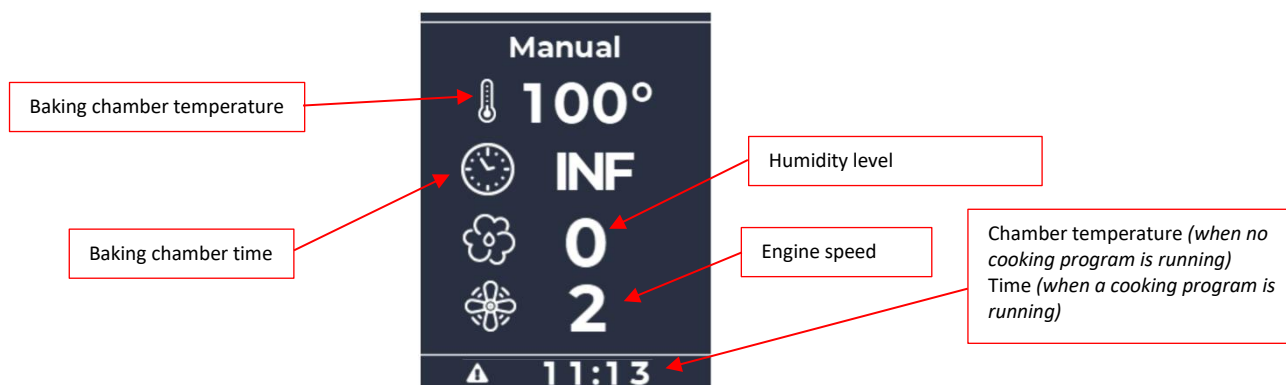

Image 2: Start screen



6.4 Display

The start screen always shows the first phase of the current program, and the parameters displayed on the start screen are defined by the following picture:



At the top of the display you can see a series of segments indicating the phases of the current cooking program:



Each time the display is turned on, starting from standby mode, the manual mode is acceded by default.

The oven status icons are displayed at the bottom of the screen.



Active flame indicator

WiFi indicator

Active alarm indicator

Chamber temperature

Active illumination indicator

Cooking cycle start/stop indicator







7. Functionalities

This oven can store in memory up to 100 cooking programs, each of which can be configured in up to 4 phases with different parameters (3 phases + preheating phase), in addition to parameters relating to the firing settings, as follows:

- Temperature
- Time
- Humidity
- Engine speed





7.1 Adjustment of parameters in phases

TEMPERATURE settings in phases

1. Press the button  to access the desired phase.
2. Press the button  to access temperature value.
3. Press buttons  to select the desired TEMPERATURE value.
4. Press the  button again to confirm the selected value..





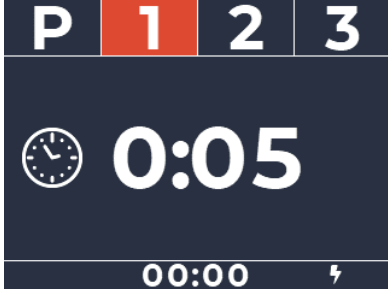

TIME settings in phases

1. Press the button  to access the desired phase.
2. Press the button  to access the TIME setting.
3. Press buttons  to select the desired TIME value.
4. Press the button again  to confirm the selected value.







HUMIDITY settings in phases

1. Press the button  to access the desired phase.
2. Press button  to access the MOISTURE setting.
3. Press buttons  to select the desired HUMIDITY value.
4. Press the button again  to confirm the selected value.







Adjustment of MOTOR SPEED in phases

1. Press button  to access the desired phase.
2. Press button  to access the SPEED setting.
3. Press buttons  to select the desired SPEED value.
4. Press the button again  to confirm the selected value.
- 5.



7.2 Last 10 recipes used





Selection of LAST RECIPE used

1. Press the button once  to access the list of the 10 most recently used last used recipes.
2. Press buttons  to position on the desired recipe.
3. Press the button once  to position on the desired recipe.
4. Press the button  to execute the selected recipe.



7.3 List of recipes/programs

Recipe/program selection

1. Press the button twice  to access the list of recipes (grouped by category), which also includes the cooling programs and manual recipe configuration..
2. Press buttons  to position yourself on the desired recipe/category.
3. Press the button once  to select the recipe/access the desired category.
4. Press the button  to execute the selected recipe.

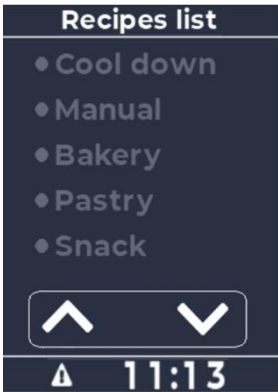

7.4 Recipe start/stop









Start or stop a recipe

1. With the desired recipe already selected, press the button  to start a cooking cycle.



7.5 Saving a recipe

Access to submenu EDIT RECIPE

1. In case you need to edit a program from scratch, select the MANUAL cooking mode and, after setting the desired parameters, press the button  three times to access the EDIT RECIPE submenu.
2. Press the buttons  to position in the SAVE function and then press the button  to access.
3. Select the desired letter by scrolling through the list using the buttons  and confirm by pressing the button .
4. Press the button  to confirm the desired name
5. Select the category in which you want to place the recipe. Use the buttons  to scroll through the list, and then press the button  to confirm.
6. To check that the saving procedure has been performed correctly, go to the category where the recipe is located and verify that it is in that group.



7.6 Editing/copying/rename a recipe

Edit recipe

1. If you need to edit an existing recipe, you must first select it and then change the parameters as explained in the previous sections. Please note that, to confirm the changes, you will need to save them.

Copy recipe

1. By using the COPY option, you can duplicate a recipe and, by editing it again, you can save it as a new recipe.

Rename recipe



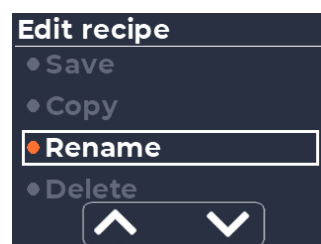
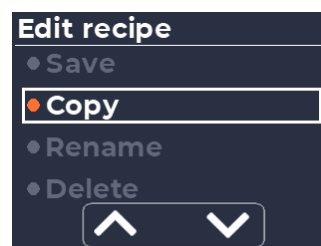
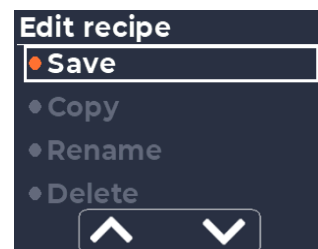



1. If you need to edit the recipe name, select the RENAME function. Any images associated with the edited program will be deleted, so it will be necessary to reassign a new one.



7.7 Quick recipe editing via external device

The FAST EDIT function allows you to manage recipes through an external device by using the WiFi network generated by the display itself.

Quick recipe editing

1. Press the button  3 times to access the EDIT RECIPE submenu.
2. Press the buttons  to position yourself on the QUICK EDIT function. Note that this option is enabled when we start this procedure from a recipe that has already been saved. **NOTE: For quick access to this function, simply press the button** .
3. Press the button  to access.
4. Scan the first QR code generated by the display to establish the link between the external device and the oven.
5. Press the button once  if we want to establish the link manually by means of the data displayed on the screen.
6. Press the button again  to access the web server provided by the oven. To do this, scan the new QR code generated by the screen.
7. Press the button again  to access the web server manually through the data displayed on the screen.

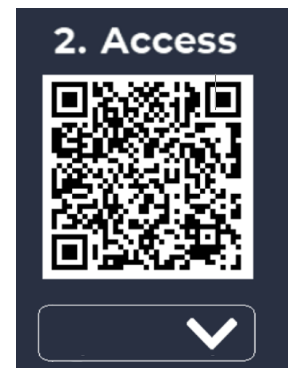
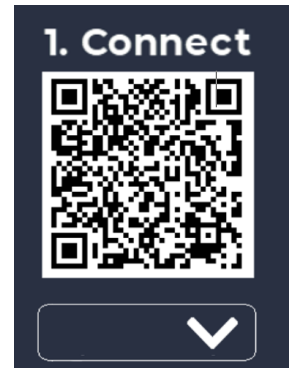

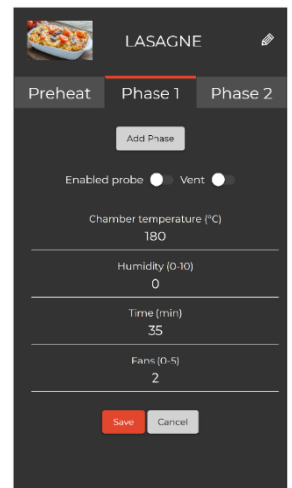

Note that the connection between the oven and the external device will remain active as long as the QUICK EDIT menu is active.

Once the connection process is completed, any parameter of the recipe can be adjusted from the external device used (name, assigned image, firing cycle values...). Once the desired parameter has been edited and saved the desired parameter, the new settings will be loaded automatically.



7.8 Deleting recipes

Access to submenu EDIT RECIPE

1. Press the button three times  to access the submenu EDIT RECIPE.
2. Press the buttons  to position yourself over the DELETE function.
3. Press the button  to confirm deletion.

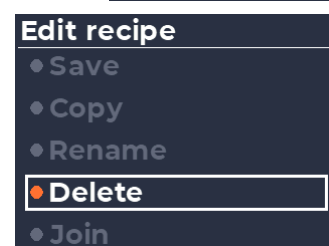
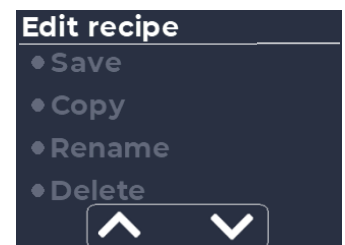





7.9 Assigning an image to a recipe (associate)



To be able to assign an image to a recipe, it must have been previously saved.

Assign image to a recipe (ASSOCIATE)

1. Press the button  to access the EDIT RECIPE submenu.
2. Press the buttons  to position on the ASSOCIATE function.
3. Press the button  to access the list of images.
4. Press the buttons  to position on the desired image.
5. Press the button  to confirm the association.

Edit recipe

- Save
- Copy
- Rename
- **Join**

↑ ↓

OCTOPUS



There is the possibility of assigning an image that does not exist in the library already available in the furnace. To do this, the image must be saved on a USB storage device, which must contain in its root directory ONLY a folder named "jpg", and where the desired images must be placed.

All images to be assigned must conform to the following format

- File type: *.jpg
- Resolution: 300x160 pixel
- Maximum size: 64Kbyte

This procedure of assigning an image to a recipe WILL NOT affect the images that the oven already has in its factory configuration, but it must be taken into account that the storage capacity of the oven is limited.







In addition, the furnace also has an additional procedure by which it is possible to replace the entire library of factory images with others more suitable to the needs of the end user (see section 8.4).



The images assigned to recipes will only be visible through the mobile device, once the link between the mobile device and the oven has been created.

7.10 Cooling program

Activate cooling program

1. Press the button  twice to access the RECIPE LIST submenu.
2. Press the buttons  to position on the cooling program.
3. Press the button  to access the program.
4. Press the button  to select the desired temperature.
5. Press the button  para seleccionar la velocidad de motor deseada **only in ovens with double speed motors models).**
6. Press the button  to start the cooling program.

• VERDURE

• PATATE ARROSTO

• **Cool down**

• Manual

• BISCOTTI

↑ ↓

Cool down

🌡️ 50°

🌀 2

⚠️ 11:20

Cool down

🌡️ 50°

⬇️ ⬅️

Cooling program progress bar



The cooling program will end once the chamber temperature is below the required set point.



The cooling program can be executed even if the door is open. If the door is closed during this period, the cooling program will be interrupted.





7.11 Adding phases to a recipe

Each recipe stored in the oven memory, including those created in MANUAL mode, consists of a preheating phase and offers the possibility of adding up to 3 additional cooking phases.

As shown in the image, the active phase has its numerical indicator highlighted (in black color), while the phases that are not active, the numerical indicator is in the background (in gray color).



- To access the list of phases of a recipe, simply press the button  once.
- To navigate through the list of phases, click on the button  until the desired phase is displayed.



If a phase is set with INFINITE TIME, it will not allow to advance to the immediately following phase



It is not possible to ELIMINATE A PHASE if the next one is active.

ACTIVE PHASE: the parameters are highlighted



NON-ACTIVE PHASE: parameters appear shaded

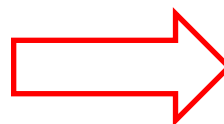

To ENABLE or ACTIVATE a PHASE, simply click on one of its adjustable parameters (time, temperature, humidity or motor speed, if the latter is adjustable) and select the desired value.







To DISABLE or DISABLE A PHASE, access the TIME parameter and set it to 0. Then, verify that both the phase indicator and the parameters of that phase remain shaded or in the background.

7.12 Preheating

All recipes, including those configured from the mono manual, have a preheating phase. By default, it is disabled, so to start it up, it must be accessed by pressing the button .

Activate cooling program

1. Press the button  once to access the list of phases
2. Press the button  the necessary number of times until it is above the preheating phase
3. Press the button  to enable or activate the preheating phase (the status indicator turns ON).
4. Press the button  to select the desired temperature.

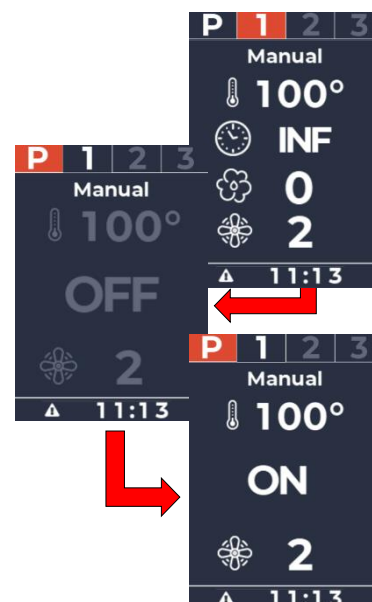

When the oven temperature reaches the selected preheating set point, an acoustic alarm is activated to warn of this event. To interrupt this alarm, simply press any button or open the oven door.

 *Once the preheating phase is finished, it will remain active until the oven door is opened. Once the door is subsequently closed, phase 1 will start automatically.*

 *If the door is opened and closed before the end of the preheating phase, that phase will be interrupted immediately.*



7.13 Setting the parameters of a recipe

Modification of the parameters of a recipe can be carried out even when the recipe is already running. As for manual recipe settings, any adjustments made before or during the cooking process are temporary, i.e. when the display is switched off at the end of the service and switched on again, the setting parameters for the manual mode will return to their default values.

 *If you need to save the preconfiguration parameters of a recipe created from the MANUAL mode, you must follow the procedure described in section 7.5.*

- To set the TEMPERATURE parameter, press the button  and then the buttons  to select the desired setpoint.

-  *The display shows the set point temperature and the thermometer icon. The color of the icon will change depending on the status of the oven (running or not).*

- To set the TIME parameter, press the button  and then the  to select the desired setpoint. If infinite time is selected, the display will show it as "INF".

-  *The display shows the setpoint time and the clock icon. The color of the icon will change depending on the status of the oven (running or not).*

- To adjust the HUMIDITY parameter, press the button  and then the buttons  to select the desired setpoint value.

-  *The display shows the selected humidity level and the water vapor cloud icon. The color of the icon will change depending on the status of the oven (running or not).*

- To adjust the value of TURBINE SPEED, press the button  and then the buttons  to select the desired setpoint value.

-  *The display shows the turbine speed and the turbine icon. The color of the icon will change depending on the status of the furnace (running or not).*

7.14 Display of the cooking time

When the oven is not running, the display will remain in STANDBY MODE, where, as mentioned in previous sections, the parameters of the cooking cycle that will be carried out when the START key is pressed can be displayed.

- If a recipe with an INFINITE cooking time is set, the display will show the timer with countdown, i.e. the total cooking time since the recipe was started will be displayed.
- If a recipe with a FINITE cooking time is set, the display will show the countdown timer, i.e. we will be able to see the remaining cooking time since the recipe was started.
- If the oven door is opened, the timer will stop.

-  *If a cooking cycle with a cooking time longer than 10 minutes is programmed, the counter will display the hour and minute digits. If the cooking cycle does not exceed 10 minutes, the counter will display the minute and second digits.*

7.15 Phase changes during a cooking cycle

During an active firing process, the upper part of the display shows a progress bar as a quick visual indication of the remaining run time of a phase. When a phase change occurs, the furnace emits an acoustic signal.



To skip a phase, simply set the time parameter of a phase to zero.

7.16 Starting, stopping or blocking a cooking cycle



To start a cooking cycle, simply press the button . In addition, if the door is opened during the execution of a cooking cycle, the process will stop immediately.

If the door is opened during one of the cooking phases, it will be temporarily stopped until it is closed again.





It should be noted that if the door is opened during the preheating phase, closing the door terminates the preheating phase and starts the effective time of the programmed recipe.

7.17 Washing

To access the wash menu, simply press the button  4 times.

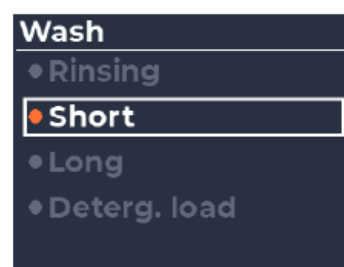
Subsequently, to select the desired washing programme, press the buttons 



Once the desired wash type has been selected, press the button  to confirm the start of the wash. Before starting the process, the display will show information about the selected option.





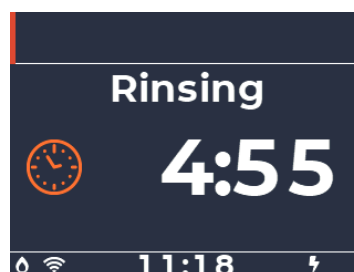

After pressing the button , the selected programme will start and the countdown of the remaining time to the end of the programme will be displayed.



8. Advanced settings

8.1 Displaying the firmware

Firmware version







1. Press four times the button  to access the submenu SERVICE.
2. Press the button   to place yourself over the option INFO.
3. Press the button  to display the information.



The diagram shows a sequence of three screenshots from a device's menu system, connected by red arrows indicating the navigation path. The first screenshot shows the 'Service' menu with options: Parameters, USB, WiFi, Info, and Language. The second screenshot shows the 'Service' menu with 'Info' selected and highlighted. The third screenshot shows the 'Info' screen displaying the following text: VER 552 REV 004.01, 27/08/2020, and 24FSTD000.

8.2 Setting date/time

Adjusting date/time

1. Press four times the button  to access the submenu SERVICE.
2. Press the buttons   to select the option DATE AND TIME.
3. Press the button  to access the configuration.
4. Set the desired parameter (year, month, day and time), by pressing the buttons   button to hover over it and the  to access and make the setting, and then to confirm the setting.



The diagram shows a sequence of three screenshots from a device's menu system, connected by red arrows indicating the navigation path. The first screenshot shows the 'Service' menu with options: WiFi, Info, Language, Date & Time, and Delete images. The second screenshot shows the 'Date & Time' configuration screen with '2020' selected and highlighted. The third screenshot shows the 'Date & Time' configuration screen with '04' selected and highlighted.

8.3 USB Menu

The USB option contained within the service submenu allows the following operations to be performed:





- Firmware update (can only be performed by an authorized service technician).
- Language update (can only be performed by an authorized service technician).
- HACCP register update (executable by the end user).
- Recipe import/export (executable by the end user).
- Parameters import/export (can only be performed by an authorized service technician).
- Image import (executable by the end user, see point 7.9).



In case the oven does not detect any USB flash drive inserted in the port, a message will appear on the screen informing about this event.

8.4 Deleting images

Deleting images

1. Press four times the button  to access the submenu SERVICE.
2. Press the buttons  to click on the option DELETE IMAGES.
3. Press the button  to access the deletion option.
4. Press the buttons  to confirm the deletion.







8.5 Loading images



The procedure discussed in this section is different from the procedure described in section 7.9. Please note that, if you perform all the steps described here, all the images already stored in the furnace will be deleted and replaced by the images stores on the external storage device.

To replace the entire image library of the oven, proceed as follows:

1. Insert the desired images to an external storage device. The root directory of this device must contain ONLY a folder called "jpg", where all the images must be placed and in which they must be in the following format:
 - File type: *.jpg
 - Maximum resolution: 300x160 pixel
 - Maximum size: 64Kbyte
2. Insert the external device into the USB port of the oven.
3. Press the button  four times to access the SERVICE submenu.
4. Press the buttons  to move to the USB option.
5. Press the button  to access to the USB option.
6. Press the buttons  to click on the option IMPORT IMAGES.
7. Press the button  to confirm the import.

8.5 HACCP export

In order to export the HACCP file to an external USB storage device, insert it into the port provided on the oven for this purpose. Then access to the menu.

9. Alarms and errors

- **Chamber probe error/failure**

REASON: this alarm is triggered if any of the following events occur:

- Short circuit in the oven chamber temperature probe wire.
- Cut in the oven chamber temperature probe wire.
- Reading error in the measuring range of the probe.

CONSEQUENCES: no firing cycles are allowed to be executed.

SOLUTION: restart the oven. If the alarm persists, contact an authorized service technician.

- **Safety thermostat**

REASON: this alarm is activated if the safety thermostat probe detects more than 300°C in the oven chamber.

CONSEQUENCES: no firing cycle is allowed to run until the temperature drops below the maximum allowable limit

SOLUTION: wait until the chamber temperature decreases and manually reset the thermostat (see status picture).

If the alarm persists, contact an authorized service technician.

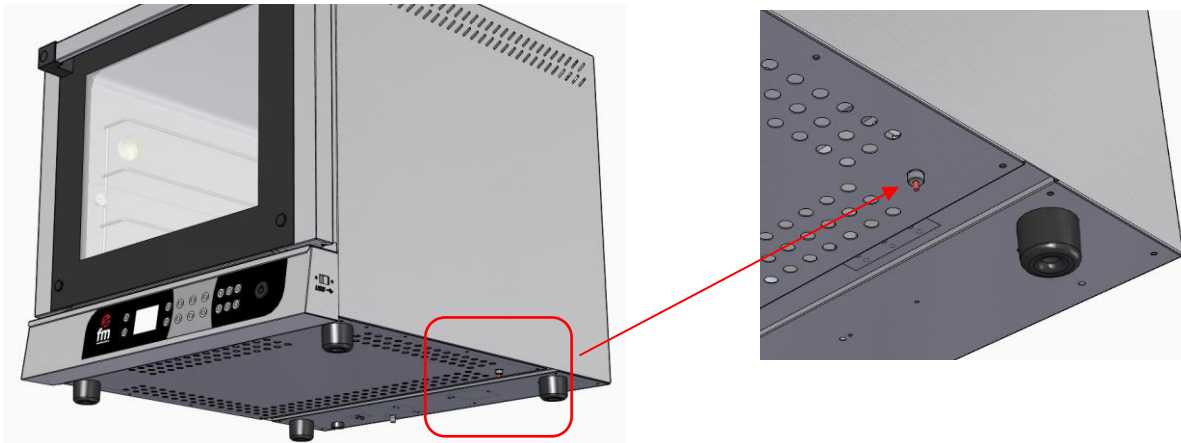

- **Power failure or power outage to the oven**

REASON: this alarm is triggered if there is a power failure during the execution of a firing cycle.

CONSEQUENCES: if the outage is less than 29 minutes, the oven will restart the cooking cycle that was in progress before the outage occurred and, in addition, a non-effective alarm will be generated informing about this event.

SOLUTION: does not apply in this case.



FM CALEFACCIÓN S.L.
B-14343594

Carretera de Rute, km. 2'700
14900 Lucena (Córdoba)
www.fmindustrial.es